

阅读申明

- 1.本站收集的数据手册和产品资料都来自互联网，版权归原作者所有。如读者和版权方有任何异议请及时告之，我们将妥善解决。
- 2.本站提供的中文数据手册是英文数据手册的中文翻译，其目的是协助用户阅读，该译文无法自动跟随原稿更新，同时也可能存在翻译上的不当。建议读者以英文原稿为参考以便获得更精准的信息。
- 3.本站提供的产品资料，来自厂商的技术支持或者使用者的心得体会等，其内容可能存在描述上的差异，建议读者做出适当判断。
- 4.如需与我们联系，请发邮件到marketing@iczoom.com，主题请标有“数据手册”字样。

Read Statement

1. The datasheets and other product information on the site are all from network reference or other public materials, and the copyright belongs to the original author and original published source. If readers and copyright owners have any objections, please contact us and we will deal with it in a timely manner.
2. The Chinese datasheets provided on the website is a Chinese translation of the English datasheets. Its purpose is for reader's learning exchange only and do not involve commercial purposes. The translation cannot be automatically updated with the original manuscript, and there may also be improper translations. Readers are advised to use the English manuscript as a reference for more accurate information.
3. All product information provided on the website refer to solutions from manufacturers' technical support or users the contents may have differences in description, and readers are advised to take the original article as the standard.
4. If you have any questions, please contact us at marketing@iczoom.com and mark the subject with "Datasheets" .

FEATURES

330 MSPS throughput rate
Triple 8-bit DACs
RS-343A-/RS-170-compatible output
Complementary outputs
DAC output current range: 2.0 mA to 26.5 mA
TTL-compatible inputs
Internal reference (1.235 V)
Single-supply +5 V/+3.3 V operation
48-lead LQFP and LFCSP
Low power dissipation (30 mW minimum at 3 V)
Low power standby mode (6 mW typical at 3 V)
Industrial temperature range (-40°C to +85°C)
RoHS compliant packages
Qualified for automotive applications

APPLICATIONS

Digital video systems
High resolution color graphics
Digital radio modulation
Image processing
Instrumentation
Video signal reconstruction
Automotive infotainment units

GENERAL DESCRIPTION

The **ADV7125** (ADV[®]) is a triple high speed, digital-to-analog converter (DAC) on a single monolithic chip. It consists of three high speed, 8-bit video DACs with complementary outputs, a standard TTL input interface, and a high impedance, analog output current source.

The **ADV7125** has three separate 8-bit-wide input ports. A single +5 V/+3.3 V power supply and clock are all that are required to make the device functional. The **ADV7125** has additional video control signals, composite $\overline{\text{SYNC}}$ and $\overline{\text{BLANK}}$, as well as a power save mode.

FUNCTIONAL BLOCK DIAGRAM

Figure 1.

The **ADV7125** is fabricated in a 5 V CMOS process. Its monolithic CMOS construction ensures greater functionality with lower power dissipation. The **ADV7125** is available in 48-lead LQFP and 48-lead LFCSP packages.

PRODUCT HIGHLIGHTS

1. 330 MSPS (3.3 V only) throughput.
2. Guaranteed monotonic to eight bits.
3. Compatible with a wide variety of high resolution color graphics systems, including RS-343A and RS-170.

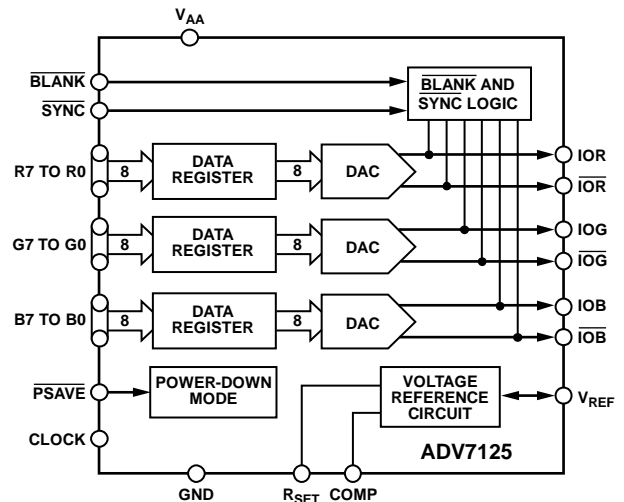
ADV7125* PRODUCT PAGE QUICK LINKS

Last Content Update: 02/23/2017

COMPARABLE PARTS

View a parametric search of comparable parts.

DOCUMENTATION

Application Notes

- AN-1180: Optimizing Video Platforms for Automated Post-Production Self-Tests
- AN-349: Keys to Longer Life for CMOS

Data Sheet

- ADV7125: CMOS, 330 MHz Triple 8-Bit High Speed Video DAC Data Sheet

TOOLS AND SIMULATIONS

- ADV7125 IBIS Models

REFERENCE DESIGNS

- CN0282

REFERENCE MATERIALS

Solutions Bulletins & Brochures

- Digital to Analog Converters ICs Solutions Bulletin

DESIGN RESOURCES

- ADV7125 Material Declaration
- PCN-PDN Information
- Quality And Reliability
- Symbols and Footprints

DISCUSSIONS

View all ADV7125 EngineerZone Discussions.

SAMPLE AND BUY

Visit the product page to see pricing options.

TECHNICAL SUPPORT

Submit a technical question or find your regional support number.

DOCUMENT FEEDBACK

Submit feedback for this data sheet.

TABLE OF CONTENTS

| | | | |
|--|----|--|----|
| Features | 1 | Circuit Description and Operation..... | 12 |
| Applications..... | 1 | Digital Inputs | 12 |
| Functional Block Diagram | 1 | Clock Input..... | 12 |
| General Description | 1 | Video Synchronization and Control..... | 13 |
| Product Highlights | 1 | Reference Input..... | 13 |
| Revision History | 2 | DACs | 13 |
| Specifications..... | 3 | Analog Outputs | 13 |
| 5 V Electrical Characteristics..... | 3 | Gray Scale Operation..... | 14 |
| 3.3 V Electrical Characteristics..... | 4 | Video Output Buffers..... | 14 |
| 5 V Timing Specifications | 5 | PCB Layout Considerations..... | 14 |
| 3.3 V Timing Specifications | 6 | Digital Signal Interconnect | 14 |
| Absolute Maximum Ratings..... | 7 | Analog Signal Interconnect..... | 15 |
| ESD Caution..... | 7 | Outline Dimensions | 16 |
| Pin Configurations and Function Descriptions | 8 | Ordering Guide | 17 |
| Terminology | 11 | Automotive Products..... | 17 |

REVISION HISTORY

4/16—Rev. C to Rev. D

| | |
|---|----|
| Changes to Figure 3 and Table 6..... | 8 |
| Added Figure 4; Renumbered Sequentially | 8 |
| Added Figure 5 and Table 7; Renumbered Sequentially | 10 |
| Updated Outline Dimensions | 16 |
| Changes to Ordering Guide | 17 |

2/11—Rev. B to Rev. C

| | |
|-------------------------|---|
| Change to Table 6 | 8 |
|-------------------------|---|

7/10—Rev. A to Rev. B

| | |
|---|----|
| Change to Features Section | 1 |
| Changes to Clock Frequency Parameter, Table 4 | 6 |
| Changes to Figure 2..... | 6 |
| Changes to Figure 4 and Figure 5..... | 11 |
| Changes to Table 7..... | 12 |
| Changes to Endnotes to Ordering Guide..... | 15 |
| Added Automotive Products Section | 15 |

3/09—Rev. 0 to Rev. A

| | |
|--|-----------|
| Updated Format..... | Universal |
| Changes to Features Section, Applications Section, and General Description Section..... | 1 |
| Changes to Figure 3 and Table 6..... | 8 |
| Deleted Ground Planes Section, Power Planes Section, and Supply Decoupling Section | 11 |
| Changes to Figure 5..... | 11 |
| Changes to Table 7, Analog Outputs Section, Figure 6, and Figure 7 | 12 |
| Changes to Video Output Buffers Section, PCB Layout Considerations Section, and Figure 9..... | 13 |
| Changes to Analog Signal Interconnect Section and Figure 10 | 14 |
| Updated Outline Dimensions..... | 15 |
| Changes to Ordering Guide..... | 16 |

10/02—Revision 0: Initial Version

SPECIFICATIONS

5 V ELECTRICAL CHARACTERISTICS

$V_{AA} = 5\text{ V} \pm 5\%$, $V_{REF} = 1.235\text{ V}$, $R_{SET} = 560\ \Omega$, $C_L = 10\text{ pF}$. All specifications T_{MIN} to T_{MAX} ,¹ unless otherwise noted, $T_{JMAX} = 110^\circ\text{C}$.

Table 1.

| Parameter | Min | Typ | Max | Unit | Test Conditions/Comments ¹ |
|--|--------|-------|--------|-------|---|
| STATIC PERFORMANCE | | | | | |
| Resolution (Each DAC) | 8 | | | Bits | |
| Integral Nonlinearity (BSL) | -1 | ±0.4 | +1 | LSB | |
| Differential Nonlinearity | -1 | ±0.25 | +1 | LSB | Guaranteed Monotonic |
| DIGITAL AND CONTROL INPUTS | | | | | |
| Input High Voltage, V_{IH} | 2 | | | V | |
| Input Low Voltage, V_{IL} | | | 0.8 | V | |
| Input Current, I_{IN} | -1 | | +1 | µA | $V_{IN} = 0.0\text{ V or }V_{DD}$ |
| PSAVE Pull-Up Current | | 20 | | µA | |
| Input Capacitance, C_{IN} | | 10 | | pF | |
| ANALOG OUTPUTS | | | | | |
| Output Current | 2.0 | | 26.5 | mA | Green DAC, $\overline{SYNC} = \text{high}$ |
| | 2.0 | | 18.5 | mA | RGB DAC, $\overline{SYNC} = \text{low}$ |
| DAC-to-DAC Matching | | 1.0 | 5 | % | |
| Output Compliance Range, V_{OC} | 0 | | 1.4 | V | |
| Output Impedance, R_{OUT} | | 100 | | kΩ | |
| Output Capacitance, C_{OUT} | | 10 | | pF | $I_{OUT} = 0\text{ mA}$ |
| Offset Error | -0.025 | | +0.025 | % FSR | Tested with DAC output = 0 V |
| Gain Error ² | -5.0 | | +5.0 | % FSR | FSR = 18.62 mA |
| VOLTAGE REFERENCE, EXTERNAL AND INTERNAL | | | | | |
| Reference Range, V_{REF} | 1.12 | 1.235 | 1.35 | V | |
| POWER DISSIPATION | | | | | |
| Digital Supply Current ³ | | 3.4 | 9 | mA | $f_{CLK} = 50\text{ MHz}$ |
| | | 10.5 | 15 | mA | $f_{CLK} = 140\text{ MHz}$ |
| | | 18 | 25 | mA | $f_{CLK} = 240\text{ MHz}$ |
| Analog Supply Current | | 67 | 72 | mA | $R_{SET} = 530\ \Omega$ |
| | | 8 | | mA | $R_{SET} = 4933\ \Omega$ |
| Standby Supply Current ⁴ | | 2.1 | 5.0 | mA | $\overline{PSAVE} = \text{low}$, digital, and control inputs at V_{DD} |
| Power Supply Rejection Ratio | | 0.1 | 0.5 | %/% | |

¹ Temperature range T_{MIN} to T_{MAX} : -40°C to $+85^\circ\text{C}$ at 50 MHz and 140 MHz, 0°C to $+70^\circ\text{C}$ at 240 MHz and 330 MHz.

² Gain error = $((\text{Measured (FSC)}/\text{Ideal (FSC)} - 1) \times 100)$, where $\text{Ideal} = V_{REF}/R_{SET} \times K \times (0x\text{FFH}) \times 4$ and $K = 7.9896$.

³ Digital supply is measured with a continuous clock that has data input corresponding to a ramp pattern and with an input level at 0 V and V_{DD} .

⁴ These maximum/minimum specifications are guaranteed by characterization in the 4.75 V to 5.25 V range.

3.3 V ELECTRICAL CHARACTERISTICS

$V_{AA} = 3.0\text{ V to }3.6\text{ V}$, $V_{REF} = 1.235\text{ V}$, $R_{SET} = 560\ \Omega$, $C_L = 10\text{ pF}$. All specifications T_{MIN} to T_{MAX} ,¹ unless otherwise noted, $T_{JMAX} = 110^\circ\text{C}$.

Table 2.

| Parameter ² | Min | Typ | Max | Unit | Test Conditions/Comments ¹ |
|-------------------------------------|------|------------|------|---------------|--|
| STATIC PERFORMANCE | | | | | |
| Resolution (Each DAC) | | | 8 | Bits | $R_{SET} = 680\ \Omega$ |
| Integral Nonlinearity (BSL) | -1 | ± 0.5 | +1 | LSB | $R_{SET} = 680\ \Omega$ |
| Differential Nonlinearity | -1 | ± 0.25 | +1 | LSB | $R_{SET} = 680\ \Omega$ |
| DIGITAL AND CONTROL INPUTS | | | | | |
| Input High Voltage, V_{IH} | 2.0 | | | V | $V_{IN} = 0.0\text{ V or }V_{DD}$ |
| Input Low Voltage, V_{IL} | | 0.8 | | V | |
| Input Current, I_{IN} | -1 | | +1 | μA | |
| PSAVE Pull-Up Current | | 20 | | μA | |
| Input Capacitance, C_{IN} | | 10 | | pF | |
| ANALOG OUTPUTS | | | | | |
| Output Current | 2.0 | | 26.5 | mA | Green DAC, $\overline{\text{SYNC}} = \text{high}$ |
| | 2.0 | | 18.5 | mA | RGB DAC, $\overline{\text{SYNC}} = \text{low}$ |
| DAC-to-DAC Matching | | 1.0 | | % | |
| Output Compliance Range, V_{OC} | 0 | | 1.4 | V | |
| Output Impedance, R_{OUT} | | 70 | | k Ω | |
| Output Capacitance, C_{OUT} | | 10 | | pF | |
| Offset Error | | 0 | 0 | % FSR | Tested with DAC output = 0 V |
| Gain Error ³ | | 0 | | % FSR | FSR = 18.62 mA |
| VOLTAGE REFERENCE, EXTERNAL | | | | | |
| Reference Range, V_{REF} | 1.12 | 1.235 | 1.35 | V | |
| VOLTAGE REFERENCE, INTERNAL | | | | | |
| Voltage Reference, V_{REF} | | 1.235 | | V | |
| POWER DISSIPATION | | | | | |
| Digital Supply Current ⁴ | | 2.2 | 5.0 | mA | $f_{CLK} = 50\text{ MHz}$ |
| | | 6.5 | 12.0 | mA | $f_{CLK} = 140\text{ MHz}$ |
| | | 11 | 15 | mA | $f_{CLK} = 240\text{ MHz}$ |
| | | 16 | | mA | $f_{CLK} = 330\text{ MHz}$ |
| Analog Supply Current | | 67 | 72 | mA | $R_{SET} = 560\ \Omega$ |
| | | 8 | | mA | $R_{SET} = 4933\ \Omega$ |
| Standby Supply Current | | 2.1 | 5.0 | mA | $\overline{\text{PSAVE}} = \text{low}$, digital, and control inputs at V_{DD} |
| Power Supply Rejection Ratio | | 0.1 | 0.5 | %/% | |

¹ Temperature range T_{MIN} to T_{MAX} : -40°C to $+85^\circ\text{C}$ at 50 MHz and 140 MHz, 0°C to $+70^\circ\text{C}$ at 240 MHz and 330 MHz.

² These max/min specifications are guaranteed by characterization in the 3.0 V to 3.6 V range.

³ Gain error = $((\text{Measured (FSC)}/\text{Ideal (FSC)} - 1) \times 100)$, where $\text{Ideal} = V_{REF}/R_{SET} \times K \times (0x\text{FFH}) \times 4$ and $K = 7.9896$.

⁴ Digital supply is measured with continuous clock that has data input corresponding to a ramp pattern and with an input level at 0 V and V_{DD} .

5 V TIMING SPECIFICATIONS

$V_{AA} = 5\text{ V} \pm 5\%$, $V_{REF} = 1.235\text{ V}$, $R_{SET} = 560\ \Omega$, $C_L = 10\text{ pF}$. All specifications T_{MIN} to T_{MAX} ,² unless otherwise noted, $T_{JMAX} = 110^\circ\text{C}$.

Table 3.

| Parameter ³ | Symbol | Min | Typ | Max | Unit | Test Conditions/Comments |
|--|-----------|-------|-----|-----|--------------|---------------------------------|
| ANALOG OUTPUTS | | | | | | |
| Analog Output Delay | t_6 | | 5.5 | | ns | |
| Analog Output Rise/Fall Time ⁴ | t_7 | | 1.0 | | ns | |
| Analog Output Transition Time ⁵ | t_8 | | 15 | | ns | |
| Analog Output Skew ⁶ | t_9 | | 1 | 2 | ns | |
| CLOCK CONTROL | | | | | | |
| CLOCK Frequency ⁷ | f_{CLK} | 0.5 | | 50 | MHz | 50 MHz grade |
| | | 0.5 | | 140 | MHz | 140 MHz grade |
| | | 0.5 | | 240 | MHz | 240 MHz grade |
| Data and Control Setup ⁶ | t_1 | 0.5 | | | ns | |
| Data and Control Hold ⁶ | t_2 | 1.5 | | | ns | |
| CLOCK Period | t_3 | 4.17 | | | ns | |
| CLOCK Pulse Width High ⁶ | t_4 | 1.875 | | | ns | $f_{CLK_MAX} = 240\text{ MHz}$ |
| CLOCK Pulse Width Low ⁶ | t_5 | 1.875 | | | ns | $f_{CLK_MAX} = 240\text{ MHz}$ |
| CLOCK Pulse Width High ⁶ | t_4 | 2.85 | | | ns | $f_{CLK_MAX} = 140\text{ MHz}$ |
| CLOCK Pulse Width Low ⁶ | t_5 | 2.85 | | | ns | $f_{CLK_MAX} = 140\text{ MHz}$ |
| CLOCK Pulse Width High | t_4 | 8.0 | | | ns | $f_{CLK_MAX} = 50\text{ MHz}$ |
| CLOCK Pulse Width Low | t_5 | 8.0 | | | ns | $f_{CLK_MAX} = 50\text{ MHz}$ |
| Pipeline Delay ⁶ | t_{PD} | 1.0 | 1.0 | 1.0 | Clock cycles | |
| PSAVE Up Time ⁶ | t_{10} | | 2 | 10 | ns | |

¹ The maximum and minimum specifications are guaranteed over this range.

² Temperature range T_{MIN} to T_{MAX} : -40°C to $+85^\circ\text{C}$ at 50 MHz and 140 MHz, 0°C to $+70^\circ\text{C}$ at 240 MHz.

³ Timing specifications are measured with input levels of 3.0 V (V_{IH}) and 0 V (V_{IL}) for both 5 V and 3.3 V supplies.

⁴ Rise time was measured from the 10% to 90% point of zero to full-scale transition, fall time from the 90% to 10% point of a full-scale transition.

⁵ Measured from 50% point of full-scale transition to 2% of final value.

⁶ Guaranteed by characterization.

⁷ f_{CLK} maximum specification production tested at 125 MHz and 5 V. Limits specified here are guaranteed by characterization.

3.3 V TIMING SPECIFICATIONS

$V_{AA} = 3.0\text{ V to }3.6\text{ V}$,¹ $V_{REF} = 1.235\text{ V}$, $R_{SET} = 560\ \Omega$, $C_L = 10\text{ pF}$. All specifications T_{MIN} to T_{MAX} ,² unless otherwise noted, $T_{JMAX} = 110^\circ\text{C}$.

Table 4.

| Parameter ³ | Symbol | Min | Typ | Max | Unit | Test Conditions/Comments |
|--|-----------|-------|-----|-----|--------------|---------------------------------|
| ANALOG OUTPUTS | | | | | | |
| Analog Output Delay, | t_6 | | 7.5 | | ns | |
| Analog Output Rise/Fall Time ⁴ | t_7 | | 1.0 | | ns | |
| Analog Output Transition Time ⁵ | t_8 | | 15 | | ns | |
| Analog Output Skew ⁶ | t_9 | | 1 | 2 | ns | |
| CLOCK CONTROL | | | | | | |
| CLOCK Frequency ⁷ | f_{CLK} | | | 50 | MHz | 50 MHz grade |
| | | | | 140 | MHz | 140 MHz grade |
| | | | | 240 | MHz | 240 MHz grade |
| | | | | 330 | MHz | 330 MHz grade |
| Data and Control Setup ⁶ | t_1 | 0.2 | | | ns | |
| Data and Control Hold ⁶ | t_2 | 1.5 | | | ns | |
| CLOCK Period | t_3 | 3 | | | ns | |
| CLOCK Pulse Width High ⁶ | t_4 | 1.4 | | | ns | $f_{CLK_MAX} = 330\text{ MHz}$ |
| CLOCK Pulse Width Low ⁶ | t_5 | 1.4 | | | ns | $f_{CLK_MAX} = 330\text{ MHz}$ |
| CLOCK Pulse Width High ⁶ | t_4 | 1.875 | | | ns | $f_{CLK_MAX} = 240\text{ MHz}$ |
| CLOCK Pulse Width Low ⁶ | t_5 | 1.875 | | | ns | $f_{CLK_MAX} = 240\text{ MHz}$ |
| CLOCK Pulse Width High ⁶ | t_4 | 2.85 | | | ns | $f_{CLK_MAX} = 140\text{ MHz}$ |
| CLOCK Pulse Width Low ⁶ | t_5 | 2.85 | | | ns | $f_{CLK_MAX} = 140\text{ MHz}$ |
| CLOCK Pulse Width High | t_4 | 8.0 | | | ns | $f_{CLK_MAX} = 50\text{ MHz}$ |
| CLOCK Pulse Width Low | t_5 | 8.0 | | | ns | $f_{CLK_MAX} = 50\text{ MHz}$ |
| Pipeline Delay ⁶ | t_{PD} | 1.0 | 1.0 | 1.0 | Clock cycles | |
| PSAVE Up Time ⁶ | t_{10} | | 4 | 10 | ns | |

¹ These maximum and minimum specifications are guaranteed over this range.

² Temperature range: T_{MIN} to T_{MAX} : -40°C to $+85^\circ\text{C}$ at 50 MHz and 140 MHz, 0°C to $+70^\circ\text{C}$ at 240 MHz and 330 MHz.

³ Timing specifications are measured with input levels of 3.0 V (V_{IH}) and 0 V (V_{IL}) for 3.3 V supplies.

⁴ Rise time was measured from the 10% to 90% point of zero to full-scale transition, fall time from the 90% to 10% point of a full-scale transition.

⁵ Measured from 50% point of full-scale transition to 2% of final value.

⁶ Guaranteed by characterization.

⁷ f_{CLK} maximum specification production tested at 125 MHz and 5 V. Limits specified here are guaranteed by characterization.

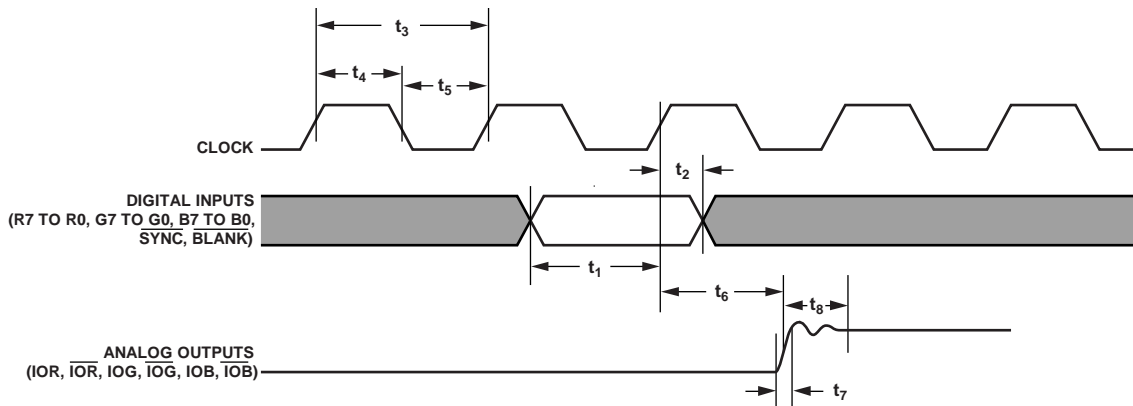

NOTES

1. OUTPUT DELAY (t_6) MEASURED FROM THE 50% POINT OF THE RISING EDGE OF CLOCK TO THE 50% POINT OF FULL-SCALE TRANSITION.
2. OUTPUT RISE/FALL TIME (t_7) MEASURED BETWEEN THE 10% AND 90% POINTS OF FULL-SCALE TRANSITION.
3. TRANSITION TIME (t_8) MEASURED FROM THE 50% POINT OF FULL-SCALE TRANSITION TO WITHIN 2% OF THE FINAL OUTPUT VALUE.

Figure 2. Timing Diagram

03957-002

ABSOLUTE MAXIMUM RATINGS

Table 5.

| Parameter | Rating |
|---|---------------------------------|
| V_{AA} to GND | 7 V |
| Voltage on Any Digital Pin | GND – 0.5 V to V_{AA} + 0.5 V |
| Ambient Operating Temperature Range (T_A) | –40°C to +85°C |
| Storage Temperature Range (T_S) | –65°C to +150°C |
| Junction Temperature (T_J) | 150°C |
| Lead Temperature (Soldering, 10 sec) | 300°C |
| Vapor Phase Soldering (1 Minute) | 220°C |
| I_{OUT} to GND ¹ | 0 V to V_{AA} |

¹ Analog output short circuit to any power supply or common GND can be of an indefinite duration.

Stresses at or above those listed under Absolute Maximum Ratings may cause permanent damage to the product. This is a stress rating only; functional operation of the product at these or any other conditions above those indicated in the operational section of this specification is not implied. Operation beyond the maximum operating conditions for extended periods may affect product reliability.

ESD CAUTION



ESD (electrostatic discharge) sensitive device. Charged devices and circuit boards can discharge without detection. Although this product features patented or proprietary protection circuitry, damage may occur on devices subjected to high energy ESD. Therefore, proper ESD precautions should be taken to avoid performance degradation or loss of functionality.

PIN CONFIGURATIONS AND FUNCTION DESCRIPTIONS

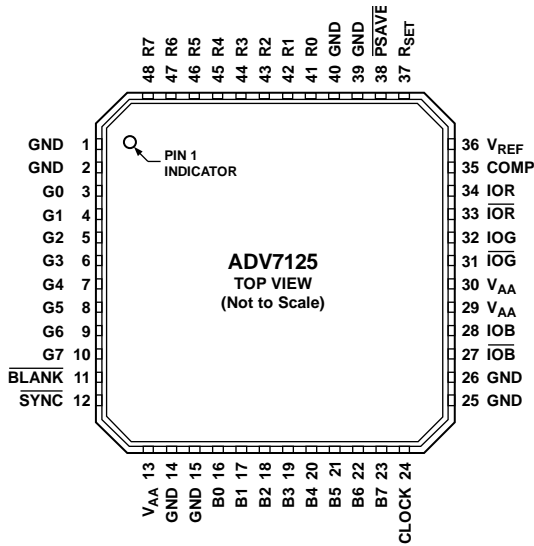

NOTES
1. THE EXPOSED PADDLE MUST BE CONNECTED TO GND.

Figure 3. LFCSP Pin Configuration (CP-48-1)

03097-003

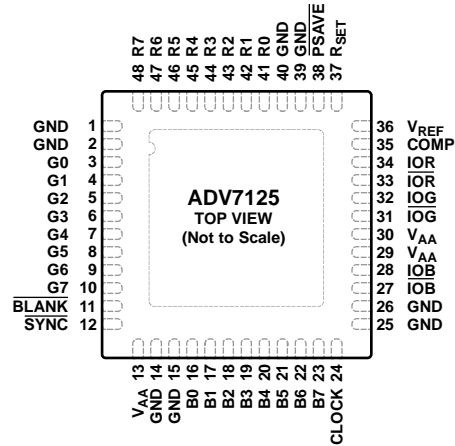

NOTES
1. THE EXPOSED PADDLE MUST BE CONNECTED TO GND.

Figure 4. LFCSP Pin Configuration (CP-48-4)

03097-100

Table 6. LFCSP Pin Function Descriptions

| Pin No. | Mnemonic | Description |
|------------------------------|------------------------------|--|
| 1, 2, 14, 15, 25, 26, 39, 40 | GND | Ground. All GND pins must be connected. |
| 3 to 10, 16 to 23, 41 to 48 | G0 to G7, B0 to B7, R0 to R7 | Red, Green, and Blue Pixel Data Inputs (TTL Compatible). Pixel data is latched on the rising edge of CLOCK. R0, G0, and B0 are the least significant data bits. Unused pixel data inputs should be connected to either the regular printed circuit board (PCB) power or ground plane. |
| 11 | BLANK | Composite Blank Control Input (TTL Compatible). A Logic 0 on this control input drives the analog outputs, IOR, IOB, and IOG, to the blanking level. The BLANK signal is latched on the rising edge of CLOCK. While BLANK is a Logic 0, the R0 to R7, G0 to G7, and B0 to B7 pixel inputs are ignored. |
| 12 | SYNC | Composite Sync Control Input (TTL Compatible). A Logic 0 on the SYNC input switches off a 40 IRE current source. This is internally connected to the IOG analog output. SYNC does not override any other control or data input; therefore, it should only be asserted during the blanking interval. SYNC is latched on the rising edge of CLOCK. If sync information is not required on the green channel, the SYNC input should be tied to Logic 0. |
| 13, 29, 30 | V _{AA} | Analog Power Supply (5 V ± 5%). All V _{AA} pins on the ADV7125 must be connected. |
| 24 | CLOCK | Clock Input (TTL Compatible). The rising edge of CLOCK latches the R0 to R7, G0 to G7, B0 to B7, SYNC, and BLANK pixel and control inputs. It is typically the pixel clock rate of the video system. CLOCK should be driven by a dedicated TTL buffer. |
| 27, 31, 33 | IOB, IOG, IOR | Differential Blue, Green, and Red Current Outputs (High Impedance Current Sources). These RGB video outputs are specified to directly drive RS-343A and RS-170 video levels into a doubly terminated 75 Ω load. If the complementary outputs are not required, these outputs should be tied to ground. |
| 28, 32, 34 | IOB, IOG, IOR | Blue, Green, and Red Current Outputs. These high impedance current sources are capable of directly driving a doubly terminated 75 Ω coaxial cable. All three current outputs should have similar output loads whether or not they are all being used. |
| 35 | COMP | Compensation Pin. This is a compensation pin for the internal reference amplifier. A 0.1 μF ceramic capacitor must be connected between COMP and V _{AA} . |
| 36 | V _{REF} | Voltage Reference Input for DACs or Voltage Reference Output (1.235 V). |

| Pin No. | Mnemonic | Description |
|---------|--------------------|--|
| 37 | R _{SET} | <p>A resistor (R_{SET}) connected between this pin and GND controls the magnitude of the full-scale video signal. Note that the IRE relationships are maintained, regardless of the full-scale output current. The relationship between R_{SET} and the full-scale output current on IOG (assuming I_{SYNC} is connected to IOG) is given by:</p> $R_{SET} (\Omega) = 11,445 \times V_{REF} (V) / IOG (mA)$ <p>The relationship between R_{SET} and the full-scale output current on IOR, IOG, and IOB is given by:</p> $IOG (mA) = 11,444.8 \times V_{REF} (V) / R_{SET} (\Omega) \text{ (}\overline{SYNC} \text{ being asserted)}$ $IOR, IOB (mA) = 7989.6 \times V_{REF} (V) / R_{SET} (\Omega)$ <p>The equation for IOG is the same as that for IOR and IOB when \overline{SYNC} is not being used, that is, \overline{SYNC} tied permanently low.</p> |
| 38 | \overline{PSAVE} | Power Save Control Pin. Reduced power consumption is available on the ADV7125 when this pin is active. |
| 0 | EPAD | Exposed Paddle. The exposed paddle must be connected to GND. |

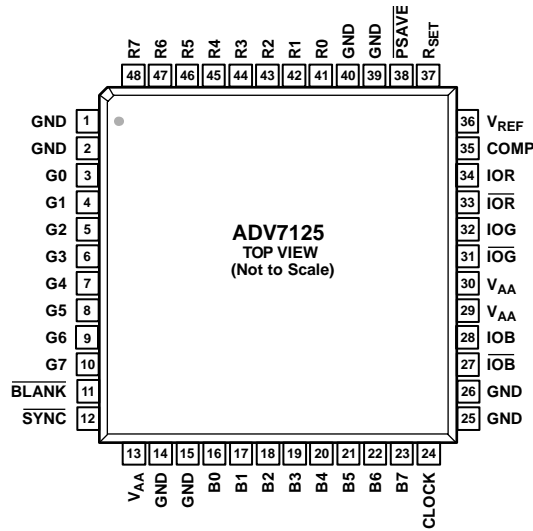

Figure 5. LQFP Pin Configuration

Table 7. LQFP Pin Function Descriptions

| Pin No. | Mnemonic | Description |
|------------------------------|------------------------------|---|
| 1, 2, 14, 15, 25, 26, 39, 40 | GND | Ground. All GND pins must be connected. |
| 3 to 10, 16 to 23, 41 to 48 | G0 to G7, B0 to B7, R0 to R7 | Red, Green, and Blue Pixel Data Inputs (TTL Compatible). Pixel data is latched on the rising edge of CLOCK. R0, G0, and B0 are the least significant data bits. Unused pixel data inputs should be connected to either the regular printed circuit board (PCB) power or ground plane. |
| 11 | BLANK | Composite Blank Control Input (TTL Compatible). A Logic 0 on this control input drives the analog outputs, IOR, IOB, and IOG, to the blanking level. The BLANK signal is latched on the rising edge of CLOCK. While BLANK is a Logic 0, the R0 to R7, G0 to G7, and B0 to B7 pixel inputs are ignored. |
| 12 | SYNC | Composite Sync Control Input (TTL Compatible). A Logic 0 on the SYNC input switches off a 40 IRE current source. This is internally connected to the IOG analog output. SYNC does not override any other control or data input; therefore, it should only be asserted during the blanking interval. SYNC is latched on the rising edge of CLOCK. If sync information is not required on the green channel, the SYNC input should be tied to Logic 0. |
| 13, 29, 30 | V _{AA} | Analog Power Supply (5 V ± 5%). All V _{AA} pins on the ADV7125 must be connected. |
| 24 | CLOCK | Clock Input (TTL Compatible). The rising edge of CLOCK latches the R0 to R7, G0 to G7, B0 to B7, SYNC, and BLANK pixel and control inputs. It is typically the pixel clock rate of the video system. CLOCK should be driven by a dedicated TTL buffer. |
| 27, 31, 33 | IOB, IOG, IOR | Differential Blue, Green, and Red Current Outputs (High Impedance Current Sources). These RGB video outputs are specified to directly drive RS-343A and RS-170 video levels into a doubly terminated 75 Ω load. If the complementary outputs are not required, these outputs should be tied to ground. |
| 28, 32, 34 | IOB, IOG, IOR | Blue, Green, and Red Current Outputs. These high impedance current sources are capable of directly driving a doubly terminated 75 Ω coaxial cable. All three current outputs should have similar output loads whether or not they are all being used. |
| 35 | COMP | Compensation Pin. This is a compensation pin for the internal reference amplifier. A 0.1 μF ceramic capacitor must be connected between COMP and V _{AA} . |
| 36 | V _{REF} | Voltage Reference Input for DACs or Voltage Reference Output (1.235 V). |
| 37 | R _{SET} | A resistor (R _{SET}) connected between this pin and GND controls the magnitude of the full-scale video signal. Note that the IRE relationships are maintained, regardless of the full-scale output current. The relationship between R _{SET} and the full-scale output current on IOG (assuming I _{SYNC} is connected to IOG) is given by: $R_{SET} (\Omega) = 11,445 \times V_{REF} (V) / IOG (mA)$ The relationship between R _{SET} and the full-scale output current on IOR, IOG, and IOB is given by: $IOG (mA) = 11,444.8 \times V_{REF} (V) / R_{SET} (\Omega) \text{ (SYNC being asserted)}$ $IOR, IOB (mA) = 7989.6 \times V_{REF} (V) / R_{SET} (\Omega)$ The equation for IOG is the same as that for IOR and IOB when SYNC is not being used, that is, SYNC tied permanently low. |
| 38 | PSAVE | Power Save Control Pin. Reduced power consumption is available on the ADV7125 when this pin is active. |

TERMINOLOGY

Blanking Level

The level separating the $\overline{\text{SYNC}}$ portion from the video portion of the waveform. Usually referred to as the front porch or back porch. At 0 IRE units, it is the level that shuts off the picture tube, resulting in the blackest possible picture.

Color Video (RGB)

This refers to the technique of combining the three primary colors of red, green, and blue to produce color pictures within the usual spectrum. In RGB monitors, three DACs are required, one for each color.

Sync Signal ($\overline{\text{SYNC}}$)

The position of the composite video signal that synchronizes the scanning process.

Gray Scale

The discrete levels of video signal between reference black and reference white levels. An 8-bit DAC contains 256 different levels.

Raster Scan

The most basic method of sweeping a CRT one line at a time to generate and display images.

Reference Black Level

The maximum negative polarity amplitude of the video signal.

Reference White Level

The maximum positive polarity amplitude of the video signal.

Sync Level

The peak level of the $\overline{\text{SYNC}}$ signal.

Video Signal

The portion of the composite video signal that varies in gray scale levels between reference white and reference black. Also referred to as the picture signal, this is the portion that can be visually observed.

CIRCUIT DESCRIPTION AND OPERATION

The **ADV7125** contains three 8-bit DACs, with three input channels, each containing an 8-bit register. Also integrated on board the device is a reference amplifier. The CRT control functions, BLANK and SYNC, are integrated on board the **ADV7125**.

DIGITAL INPUTS

There are 24 bits of pixel data (color information), R0 to R7, G0 to G7, and B0 to B7, latched into the device on the rising edge of each clock cycle. This data is presented to the three 8-bit DACs and then converted to three analog (RGB) output waveforms (see Figure 6).

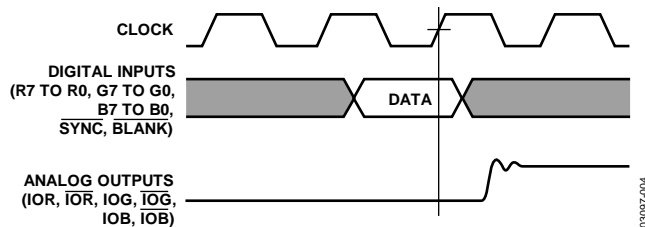
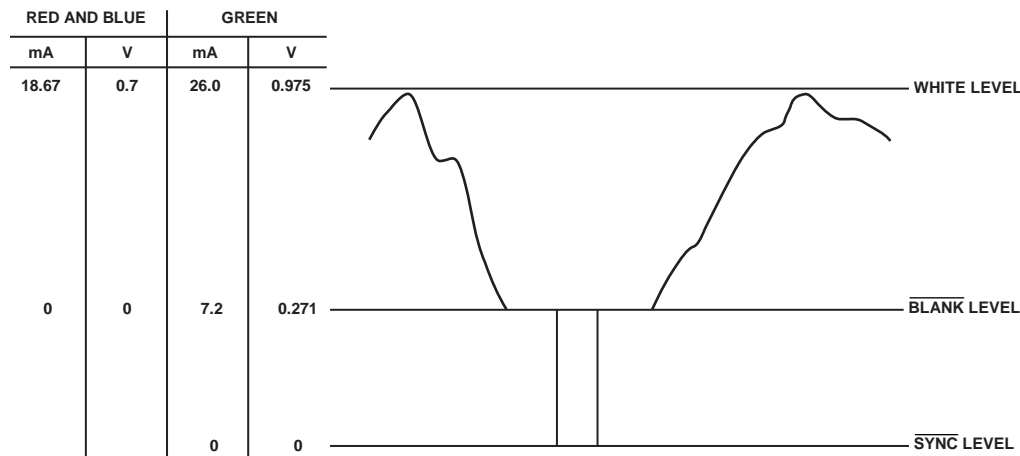

Figure 6. Video Data Input/Output

The **ADV7125** has two additional control signals that are latched to the analog video outputs in a similar fashion. BLANK and SYNC are each latched on the rising edge of CLOCK to maintain synchronization with the pixel data stream.

The BLANK and SYNC functions allow for the encoding of these video synchronization signals onto the RGB video output. This is done by adding appropriately weighted current sources to the analog outputs, as determined by the logic levels on the BLANK and SYNC digital inputs.

Figure 7 shows the analog output, RGB video waveform of the **ADV7125**. The influence of SYNC and BLANK on the analog video waveform is illustrated.



- NOTES
1. OUTPUTS CONNECTED TO A DOUBLY TERMINATED 75Ω LOAD.
 2. $V_{REF} = 1.235V$, $R_{SET} = 530\Omega$.
 3. RS-343 LEVELS AND TOLERANCES ASSUMED ON ALL LEVELS.

Figure 7. Typical RGB Video Output Waveform

Table 8 details the resultant effect on the analog outputs of BLANK and SYNC.

All these digital inputs are specified to accept TTL logic levels.

CLOCK INPUT

The CLOCK input of the **ADV7125** is typically the pixel clock rate of the system. It is also known as the dot rate. The dot rate, and thus the required CLOCK frequency, is determined by the on-screen resolution, according to the following equation:

$$Dot\ Rate = (Horiz\ Res) \times (Vert\ Res) \times (Refresh\ Rate) / (Retrace\ Factor)$$

where:

Horiz Res is the number of pixels per line.

Vert Res is the number of lines per frame.

Refresh Rate is the horizontal scan rate. This is the rate at which the screen must be refreshed, typically 60 Hz for a noninterlaced system, or 30 Hz for an interlaced system.

Retrace Factor is the total blank time factor. This takes into account that the display is blanked for a certain fraction of the total duration of each frame (for example, 0.8).

Therefore, for a graphics system with a 1024 × 1024 resolution, a noninterlaced 60 Hz refresh rate, and a retrace factor of 0.8,

$$Dot\ Rate = 1024 \times 1024 \times 60 / 0.8 = 78.6\ MHz$$

The required CLOCK frequency is thus 78.6 MHz. All video data and control inputs are latched into the **ADV7125** on the rising edge of CLOCK, as previously described in the Digital Inputs section. It is recommended that the CLOCK input to the **ADV7125** be driven by a TTL buffer (for example, the 74F244).

Table 8. Typical Video Output Truth Table (R_{SET} = 530 Ω, R_{LOAD} = 37.5 Ω)

| Video Output Level | I _{OG} (mA) | I _{OG} (mA) | I _{OR} /I _{OB} (mA) | I _{OR} /I _{OB} (mA) | SYNC | BLANK | DAC Input Data |
|--------------------|----------------------|----------------------|---------------------------------------|---------------------------------------|------|-------|-------------------|
| White Level | 26.0 | 0 | 18.67 | 0 | 1 | 1 | 0xFFH |
| Video | Video + 7.2 | 18.67 – Video | Video | 18.67 – Video | 1 | 1 | Data |
| Video to BLANK | Video | 18.67 – Video | Video | 18.67 – Video | 0 | 1 | Data |
| Black Level | 7.2 | 18.67 | 0 | 18.67 | 1 | 1 | 0x00H |
| Black to BLANK | 0 | 18.67 | 0 | 18.67 | 0 | 1 | 0x00H |
| BLANK Level | 7.2 | 18.67 | 0 | 18.67 | 1 | 0 | 0XXH (don't care) |
| SYNC Level | 0 | 18.67 | 0 | 18.67 | 0 | 0 | 0XXH (don't care) |

VIDEO SYNCHRONIZATION AND CONTROL

The ADV7125 has a single composite sync (SYNC) input control. Many graphics processors and CRT controllers have the ability to generate horizontal sync (HSYNC), vertical sync (VSYNC), and composite SYNC.

In a graphics system that does not automatically generate a composite SYNC signal, the inclusion of some additional logic circuitry enables the generation of a composite SYNC signal.

The sync current is internally connected directly to the IOG output, thus encoding video synchronization information onto the green video channel. If it is not required to encode sync information onto the ADV7125, the SYNC input should be tied to logic low.

REFERENCE INPUT

The ADV7125 contains an on-board voltage reference. The V_{REF} pin should be connected as shown in Figure 12.

A resistance, R_{SET}, connected between the R_{SET} pin and GND, determines the amplitude of the output video level according to Equation 1 and Equation 2 for the ADV7125.

$$I_{OG} \text{ (mA)} = 11,444.8 \times V_{REF} \text{ (V)} / R_{SET} \text{ (}\Omega\text{)} \tag{1}$$

$$I_{OR}, I_{OB} \text{ (mA)} = 7989.6 \times V_{REF} \text{ (V)} / R_{SET} \text{ (}\Omega\text{)} \tag{2}$$

Equation 1 applies to the ADV7125 only, when SYNC is being used. If SYNC is not being encoded onto the green channel, Equation 1 is similar to Equation 2.

Using a variable value of R_{SET} allows for accurate adjustment of the analog output video levels. Use of a fixed 560 Ω R_{SET} resistor yields the analog output levels quoted in the Specifications section. These values typically correspond to the RS-343A video waveform values, as shown in Figure 7.

DACs

The ADV7125 contains three matched 8-bit DACs. The DACs are designed using an advanced, high speed, segmented architecture. The bit currents corresponding to each digital input are routed to either the analog output (bit = 1) or GND (bit = 0) by a sophisticated decoding scheme. Because all this circuitry is on one monolithic device, matching between the three DACs is optimized. As well as matching, the use of identical current sources in a monolithic design guarantees monotonicity and low glitch. The on-board operational amplifier stabilizes the

full-scale output current against temperature and power supply variations.

ANALOG OUTPUTS

The ADV7125 has three analog outputs, corresponding to the red, green, and blue video signals.

The red, green, and blue analog outputs of the ADV7125 are high impedance current sources. Each one of these three RGB current outputs is capable of directly driving a 37.5 Ω load, such as a doubly terminated 75 Ω coaxial cable. Figure 8 shows the required configuration for each of the three RGB outputs connected into a doubly terminated 75 Ω load. This arrangement develops RS-343A video output voltage levels across a 75 Ω monitor.

A suggested method of driving RS-170 video levels into a 75 Ω monitor is shown in Figure 9. The output current levels of the DACs remain unchanged, but the source termination resistance, Z_S, on each of the three DACs is increased from 75 Ω to 150 Ω.

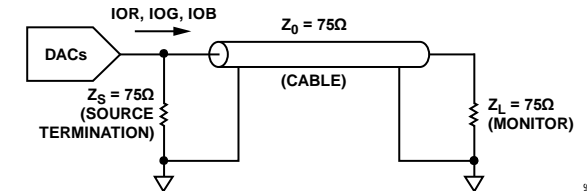

TERMINATION REPEATED THREE TIMES FOR RED, GREEN, AND BLUE DACs

Figure 8. Analog Output Termination for RS-343A

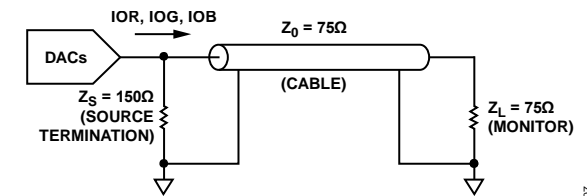

TERMINATION REPEATED THREE TIMES FOR RED, GREEN, AND BLUE DACs

Figure 9. Analog Output Termination for RS-170

More detailed information regarding load terminations for various output configurations, including RS-343A and RS-170, is available in the AN-205 Application Note, Video Formats and Required Load Terminations.

Figure 7 shows the video waveforms associated with the three RGB outputs driving the doubly terminated 75 Ω load of Figure 8. As well as the gray scale levels (black level to white

level), Figure 7 also shows the contributions of SYNC and BLANK for the ADV7125. These control inputs add appropriately weighted currents to the analog outputs, producing the specific output level requirements for video applications. Table 8 details how the SYNC and BLANK inputs modify the output levels.

GRAY SCALE OPERATION

The ADV7125 can be used for standalone, gray scale (monochrome) or composite video applications (that is, only one channel used for video information). Any one of the three channels, red, green, or blue, can be used to input the digital video data. The two unused video data channels should be tied to Logic 0. The unused analog outputs should be terminated with the same load as that for the used channel, that is, if the red channel is used and IOR is terminated with a doubly terminated 75 Ω load (37.5 Ω), IOB and IOG should be terminated with 37.5 Ω resistors (see Figure 10).

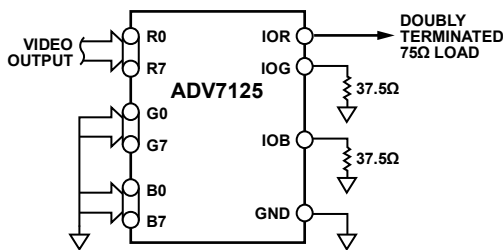

Figure 10. Input and Output Connections for Standalone Gray Scale or Composite Video

VIDEO OUTPUT BUFFERS

The ADV7125 is specified to drive transmission line loads. The analog output configuration to drive such loads is described in the Analog Outputs section and illustrated in Figure 11. However, in some applications, it may be required to drive long transmission line cable lengths. Cable lengths greater than 10 meters can attenuate and distort high frequency analog output pulses. The inclusion of output buffers compensates for some cable distortion. Buffers with large full power bandwidths and gains between two and four are required. These buffers also need to be able to supply sufficient current over the complete output voltage swing. Analog Devices produces a range of suitable op amps for such applications. These include the AD843, AD844, AD847, and AD848 series of monolithic op amps. In very high frequency applications (80 MHz), the AD8061 is recommended. More information on line driver buffering circuits is given in the relevant op amp data sheets.

Use of buffer amplifiers also allows implementation of other video standards besides RS-343A and RS-170. Altering the gain components of the buffer circuit results in any desired video level.

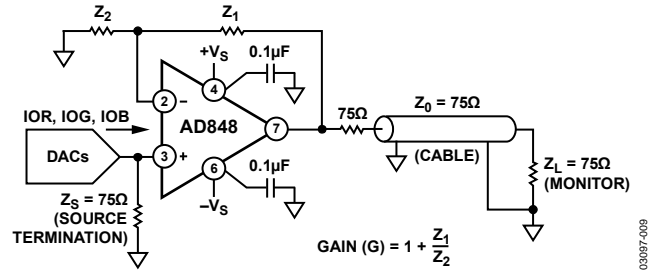

Figure 11. AD848 as an Output Buffer

PCB LAYOUT CONSIDERATIONS

The ADV7125 is optimally designed for lowest noise performance, both radiated and conducted noise. To complement the excellent noise performance of the ADV7125, it is imperative that great care be given to the PCB layout. Figure 12 shows a recommended connection diagram for the ADV7125.

The layout should be optimized for lowest noise on the ADV7125 power and ground lines. This can be achieved by shielding the digital inputs and providing good decoupling. Shorten the lead length between groups of VAA and GND pins to minimize inductive ringing.

It is recommended to use a 4-layer printed circuit board with a single ground plane. The ground and power planes should separate the signal trace layer and the solder side layer. Noise on the analog power plane can be further reduced by using multiple decoupling capacitors (see Figure 12). Optimum performance is achieved by using 0.1 μF and 0.01 μF ceramic capacitors. Individually decouple each VAA pin to ground by placing the capacitors as close as possible to the device with the capacitor leads as short as possible, thus minimizing lead inductance. It is important to note that while the ADV7125 contains circuitry to reject power supply noise, this rejection decreases with frequency. If a high frequency switching power supply is used, pay close attention to reducing power supply noise. A dc power supply filter (Murata BNX002) provides EMI suppression between the switching power supply and the main PCB. Alternatively, consideration can be given to using a 3-terminal voltage regulator.

DIGITAL SIGNAL INTERCONNECT

Isolate the digital signal lines to the ADV7125 as much as possible from the analog outputs and other analog circuitry. Digital signal lines should not overlay the analog power plane.

Due to the high clock rates used, long clock lines to the ADV7125 should be avoided to minimize noise pickup.

Connect any active pull-up termination resistors for the digital inputs to the regular PCB power plane (VCC) and not to the analog power plane.

ANALOG SIGNAL INTERCONNECT

Place the [ADV7125](#) as close as possible to the output connectors, thus minimizing noise pickup and reflections due to impedance mismatch.

The video output signals should overlay the ground plane and not the analog power plane, thereby maximizing the high frequency power supply rejection.

For optimum performance, the analog outputs should each have a source termination resistance to ground of 75 Ω (doubly terminated 75 Ω configuration). This termination resistance should be as close as possible to the [ADV7125](#) to minimize reflections.

Additional information on PCB design is available in the [AN-333 Application Note](#), *Design and Layout of a Video Graphics System for Reduced EMI*.

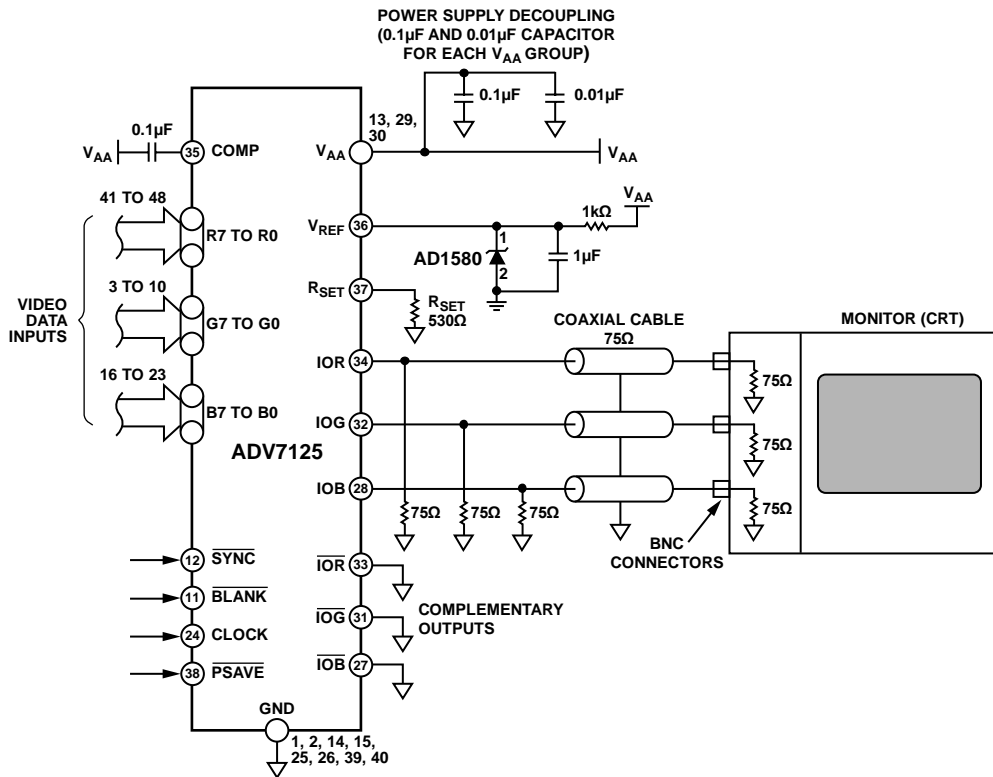
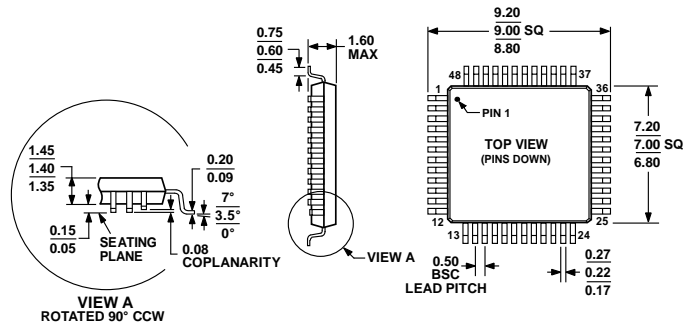

Figure 12. Typical Connection Diagram

03097-010

OUTLINE DIMENSIONS



COMPLIANT TO JEDEC STANDARDS MS-026-BBC

Figure 13. 48-Lead Low Profile Quad Flat Package [LQFP] (ST-48)

Dimensions shown in millimeters

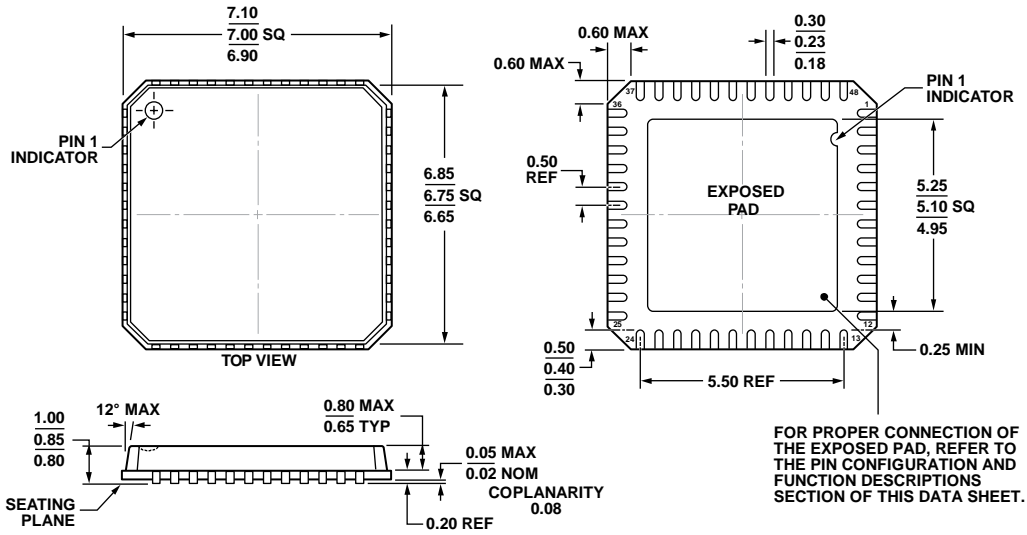

COMPLIANT TO JEDEC STANDARDS MO-220-VKGD-2

Figure 14. 48-Lead Lead Frame Chip Scale Package [LFCSP] 7 mm x 7 mm Body and 0.85 mm Package Height (CP-48-1)

Dimensions shown in millimeters

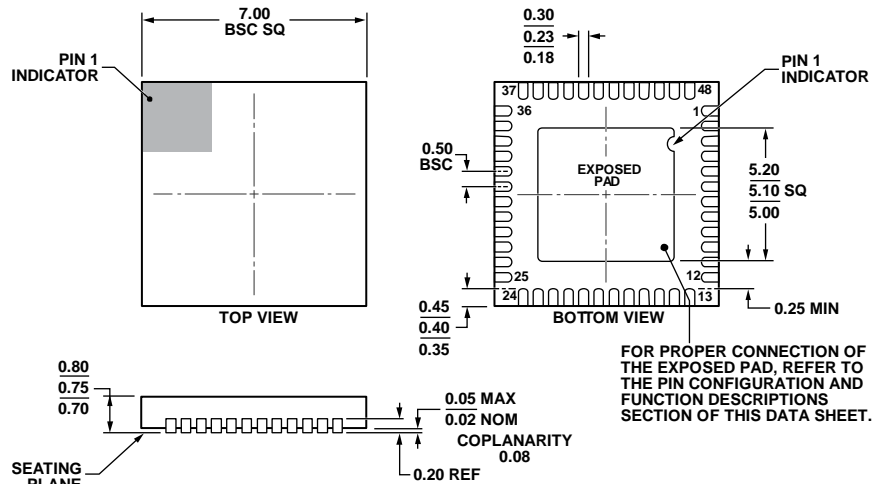

COMPLIANT TO JEDEC STANDARDS MO-220-WKGD.

Figure 15. 48-Lead Lead Frame Chip Scale Package [LFCSP]
7 mm × 7 mm Body and 0.75 mm Package Height
(CP-48-4)

Dimensions shown in millimeters

112408-B

ORDERING GUIDE

| Model ^{1, 2, 3} | Temperature Range | Package Description | Speed Option | Package Option |
|--------------------------|-------------------|---|--------------|----------------|
| ADV7125KSTZ50 | -40°C to +85°C | 48-Lead Low Profile Quad Flat Package [LQFP] | 50 MHz | ST-48 |
| ADV7125KSTZ50-REEL | -40°C to +85°C | 48-Lead Low Profile Quad Flat Package [LQFP] | 50 MHz | ST-48 |
| ADV7125KSTZ140 | -40°C to +85°C | 48-Lead Low Profile Quad Flat Package [LQFP] | 140 MHz | ST-48 |
| ADV7125JSTZ240 | 0°C to +70°C | 48-Lead Low Profile Quad Flat Package [LQFP] | 240 MHz | ST-48 |
| ADV7125JSTZ330 | 0°C to +70°C | 48-Lead Low Profile Quad Flat Package [LQFP] | 330 MHz | ST-48 |
| ADV7125WBSTZ170 | -40°C to +85°C | 48-Lead Low Profile Quad Flat Package [LQFP] | 170 MHz | ST-48 |
| ADV7125WBSTZ170-RL | -40°C to +85°C | 48-Lead Low Profile Quad Flat Package [LQFP] | 170 MHz | ST-48 |
| ADV7125BCPZ170 | -40°C to +85°C | 48-Lead Lead Frame Chip Scale Package [LFCSP] | 170 MHz | CP-48-1 |
| ADV7125BCPZ170-RL | -40°C to +85°C | 48-Lead Lead Frame Chip Scale Package [LFCSP] | 170 MHz | CP-48-1 |
| ADV7125WBSPZ170 | -40°C to +85°C | 48-Lead Lead Frame Chip Scale Package [LFCSP] | 170 MHz | CP-48-4 |
| ADV7125WBSPZ170-RL | -40°C to +85°C | 48-Lead Lead Frame Chip Scale Package [LFCSP] | 170 MHz | CP-48-4 |

¹ Z = RoHS Compliant Part.

² W = Qualified for Automotive Applications.

³ ADV7125JSTZ330 is available in a 3.3 V option only.

AUTOMOTIVE PRODUCTS

The **ADV7125W** models are available with controlled manufacturing to support the quality and reliability requirements of automotive applications. Note that these automotive models may have specifications that differ from the commercial models; therefore, designers should review the Specifications section of this data sheet carefully. Only the automotive grade products shown are available for use in automotive applications. Contact your local Analog Devices account representative for specific product ordering information and to obtain the specific Automotive Reliability reports for these models.